

S/N: _____

Inventor: Shen Buswell et al

Title: Methods and systems for a forming slots in a semiconductor substrate containing . . .

100

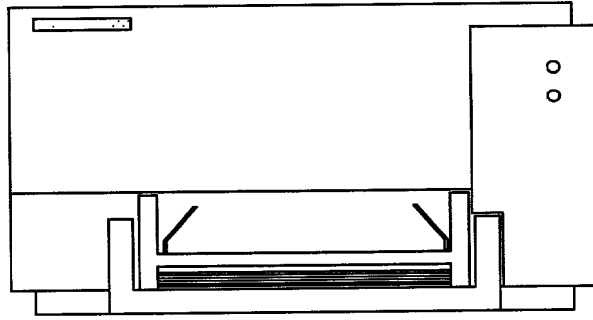

Fig.1

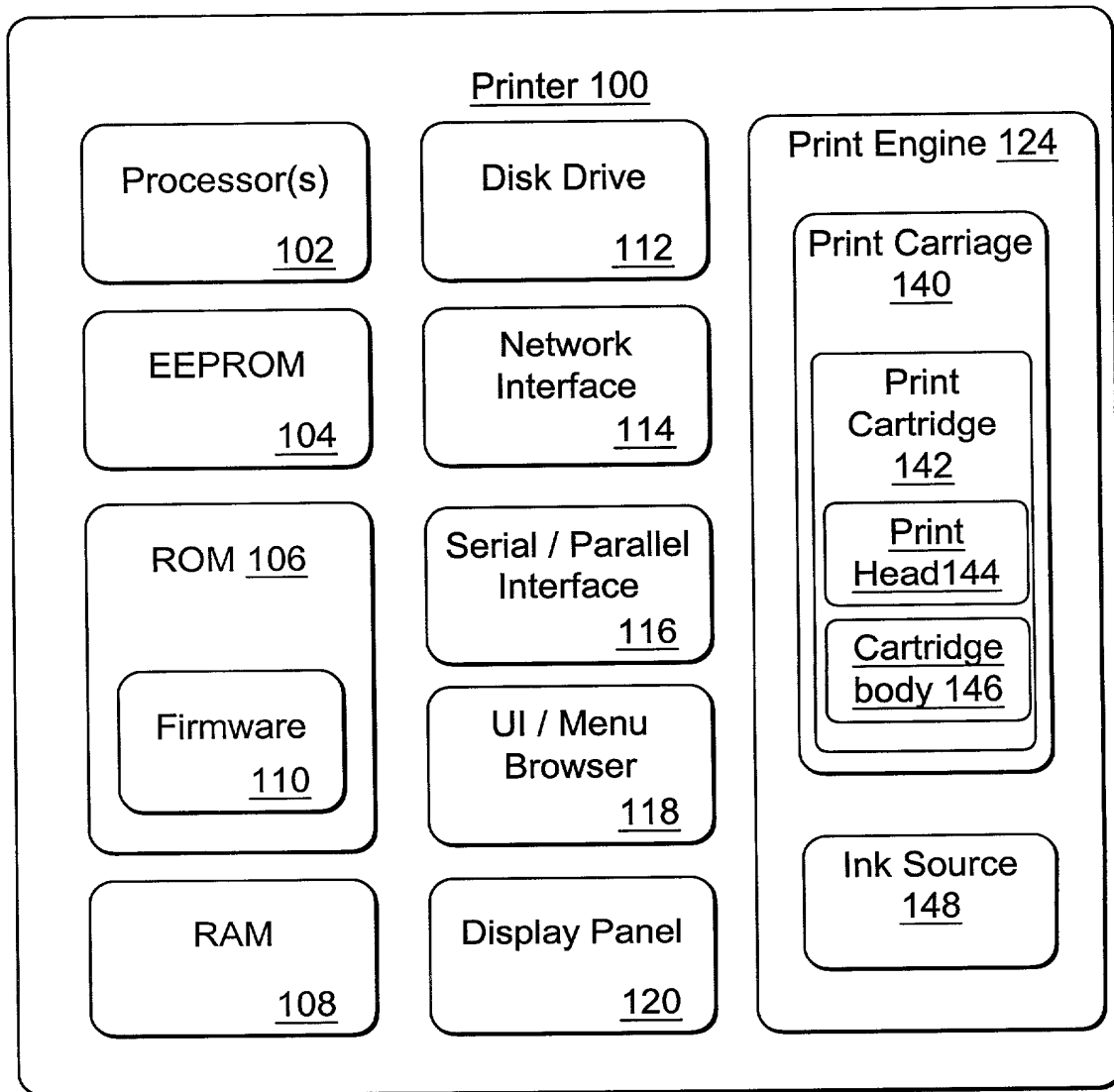

Fig. 2

20110720 14:58:00

S/N: _____

Inventor: Shen Buswell et al

Title: Methods and systems for a forming slots in a semiconductor substrate containing ...

20140226

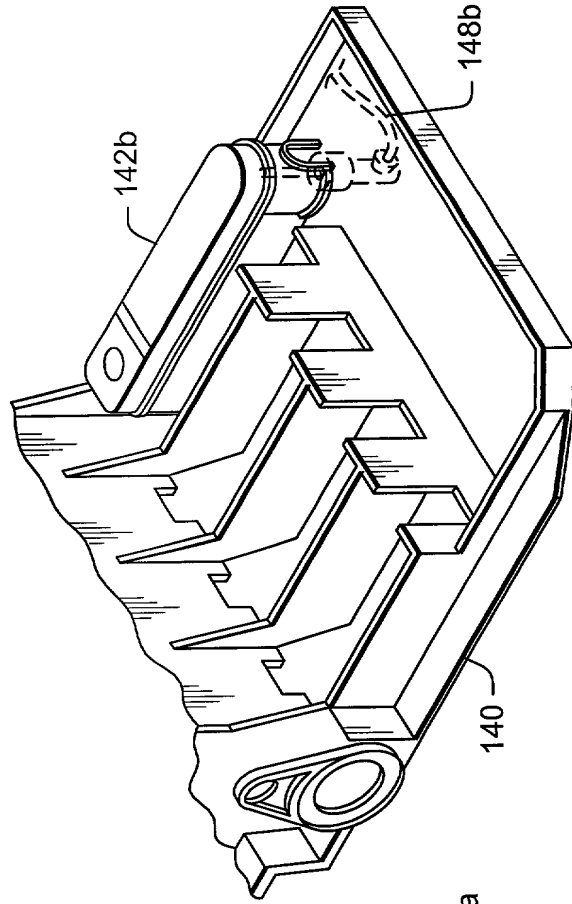

FIG. 3

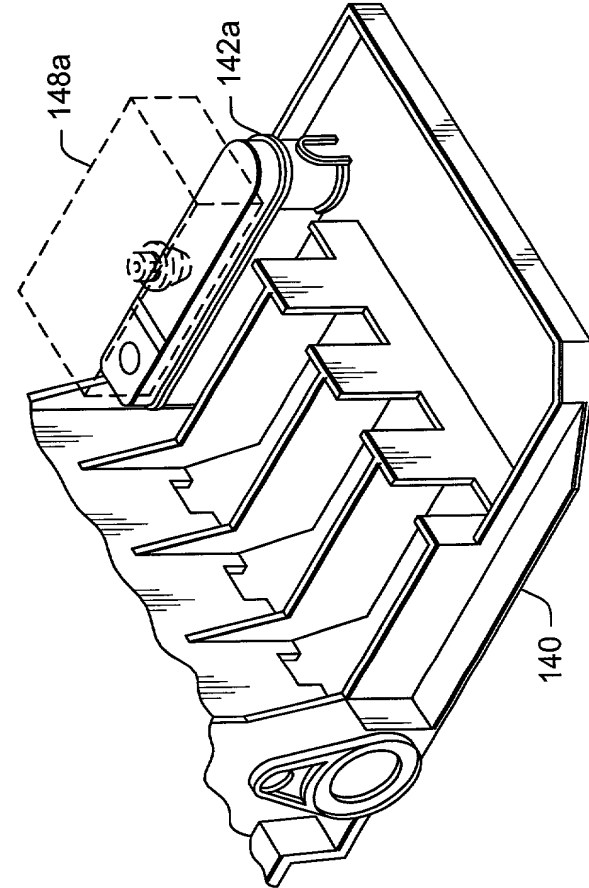

FIG. 4

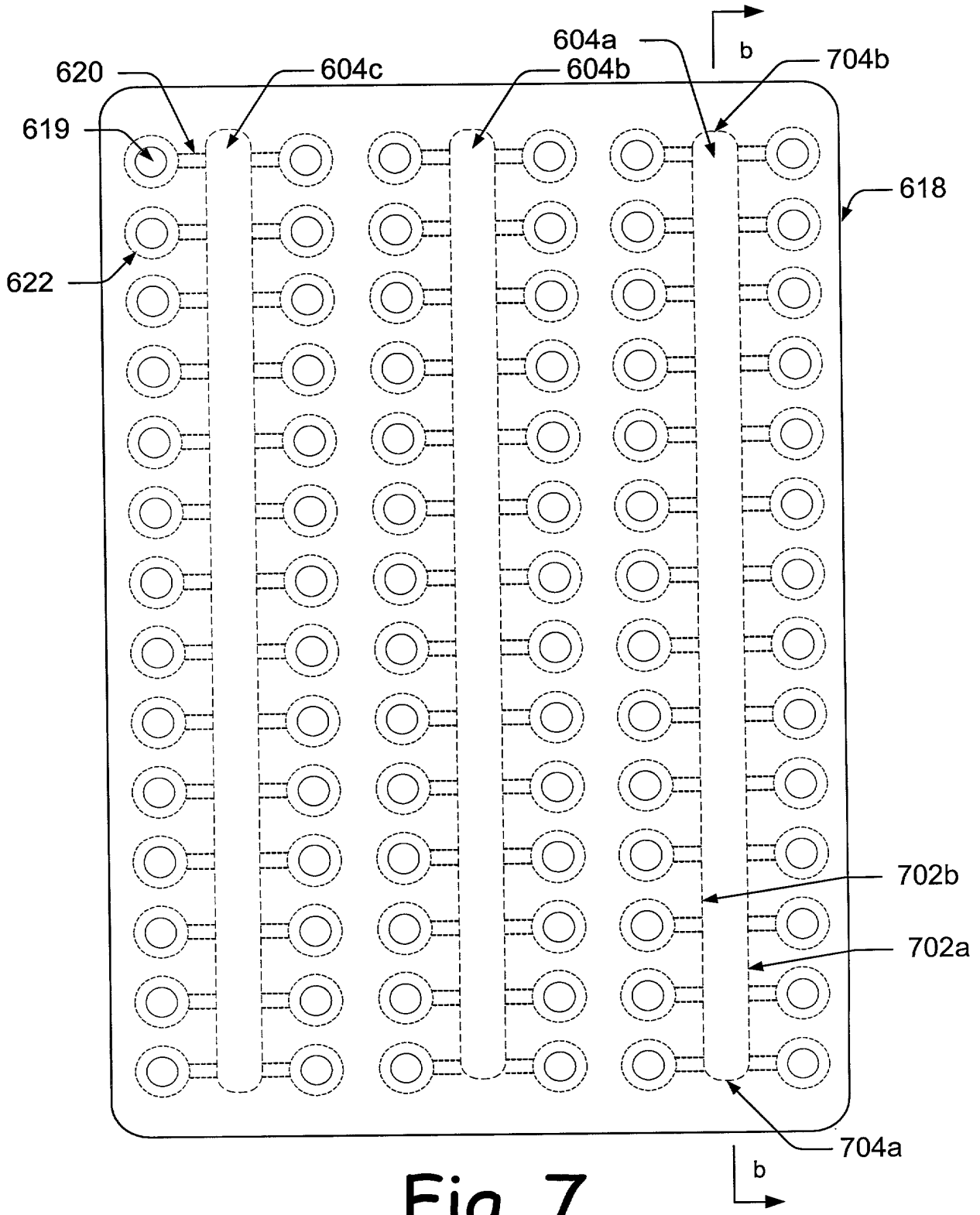

Fig. 7

20250720 14:50:00

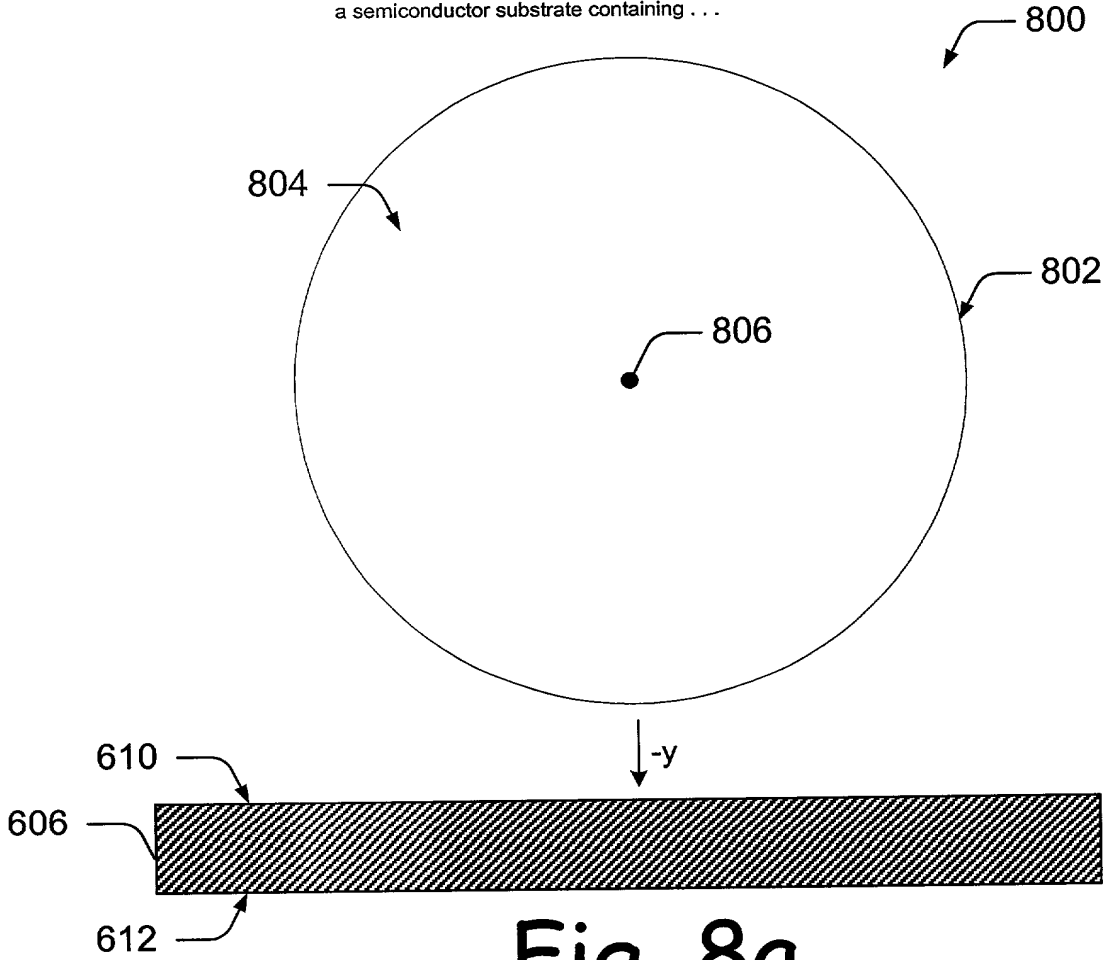

Fig. 8a

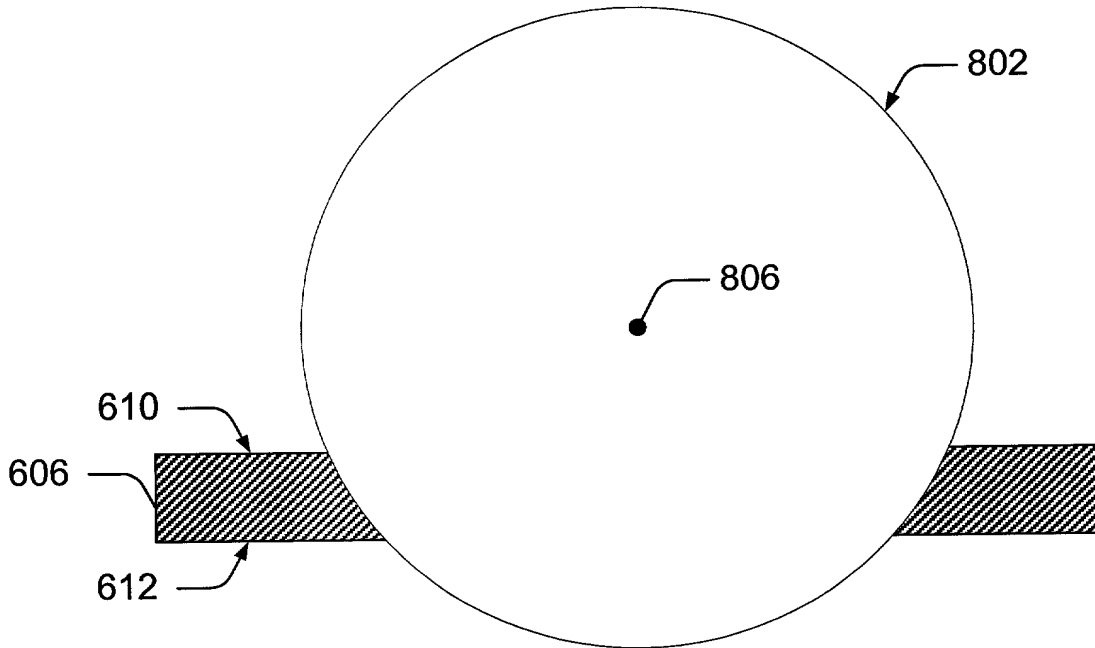

Fig. 8b

2025 RELEASE UNDER E.O. 14176

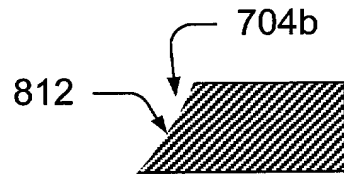
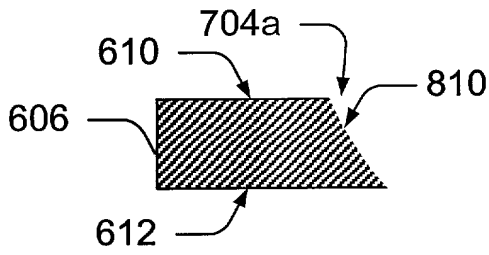

Fig. 8c

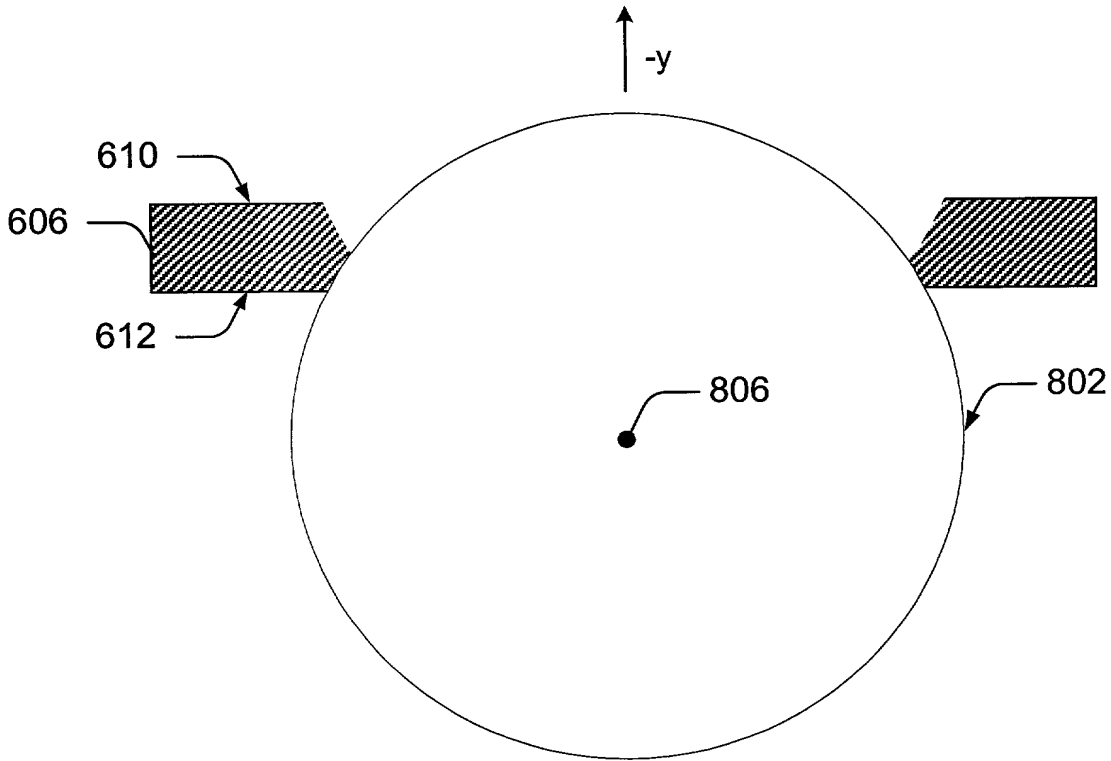

Fig. 8d

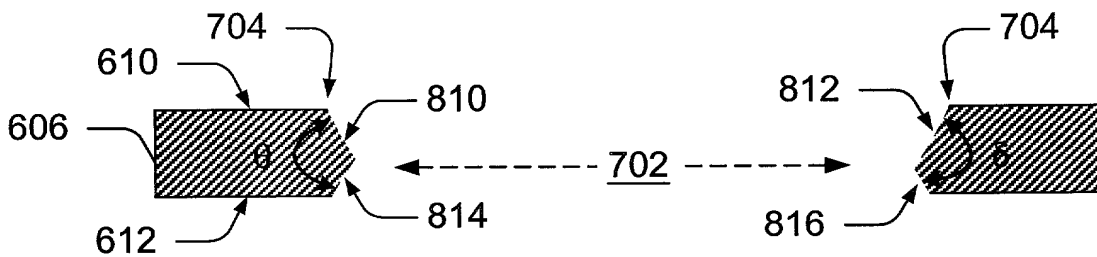

Fig. 8e

20250726 14:54:00

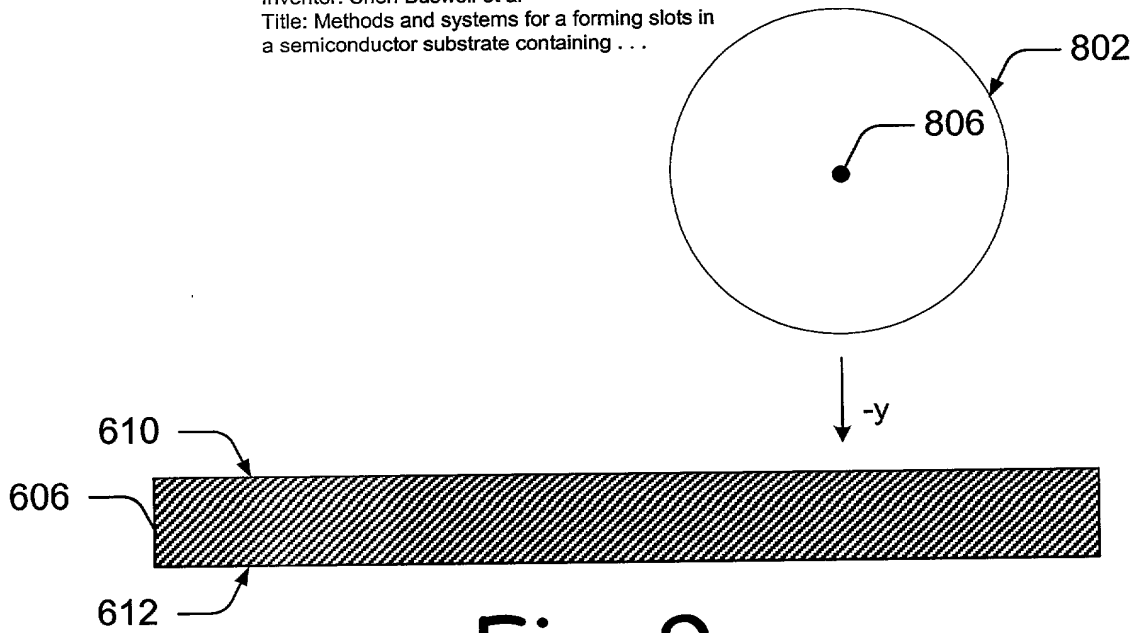

Fig. 9a

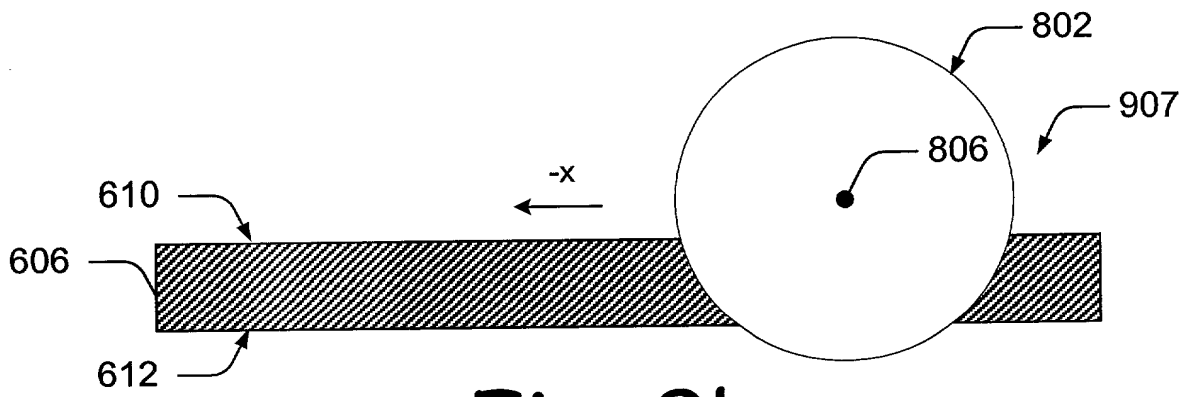

Fig. 9b

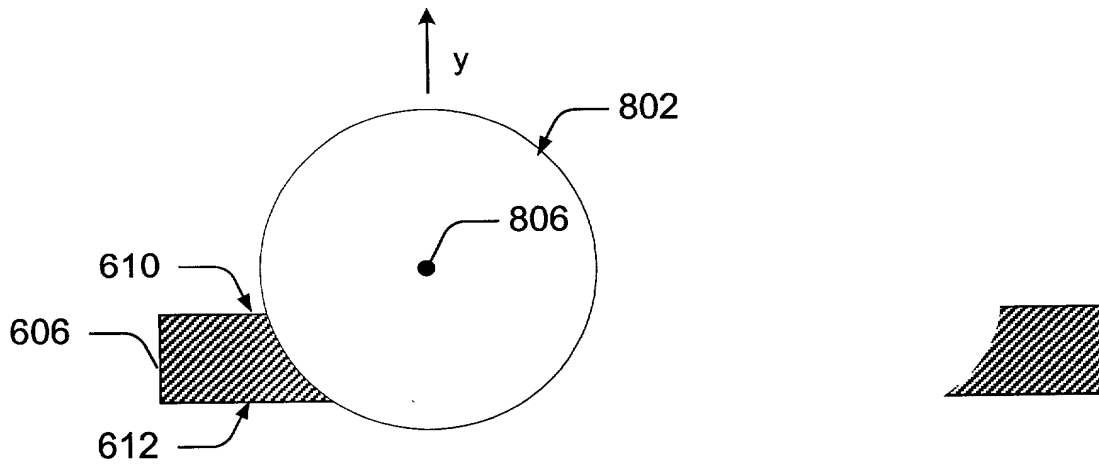

Fig. 9c

20250726 14:54:00

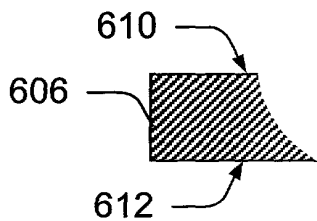

Fig. 9d

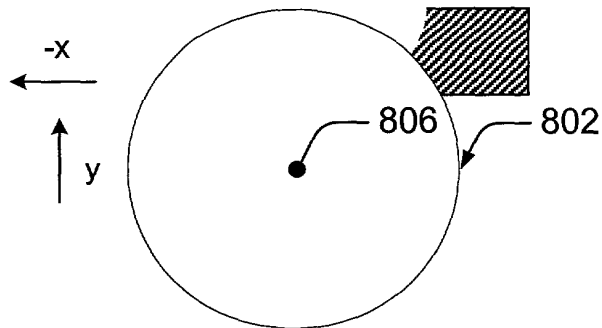
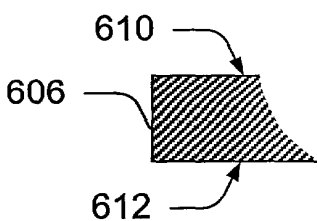

Fig. 9e

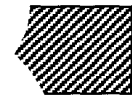
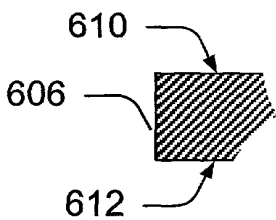

Fig. 9f

20160728

20250719 14:54:49

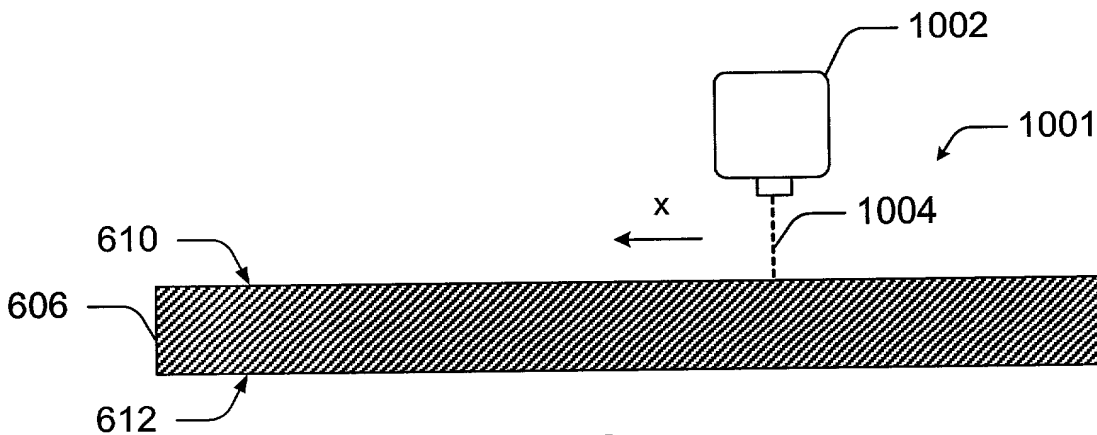

Fig. 10a

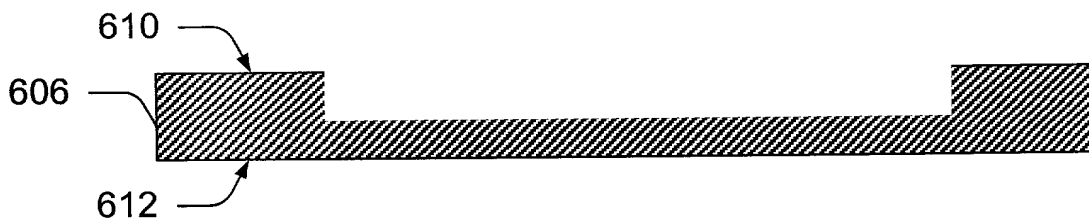

Fig. 10b

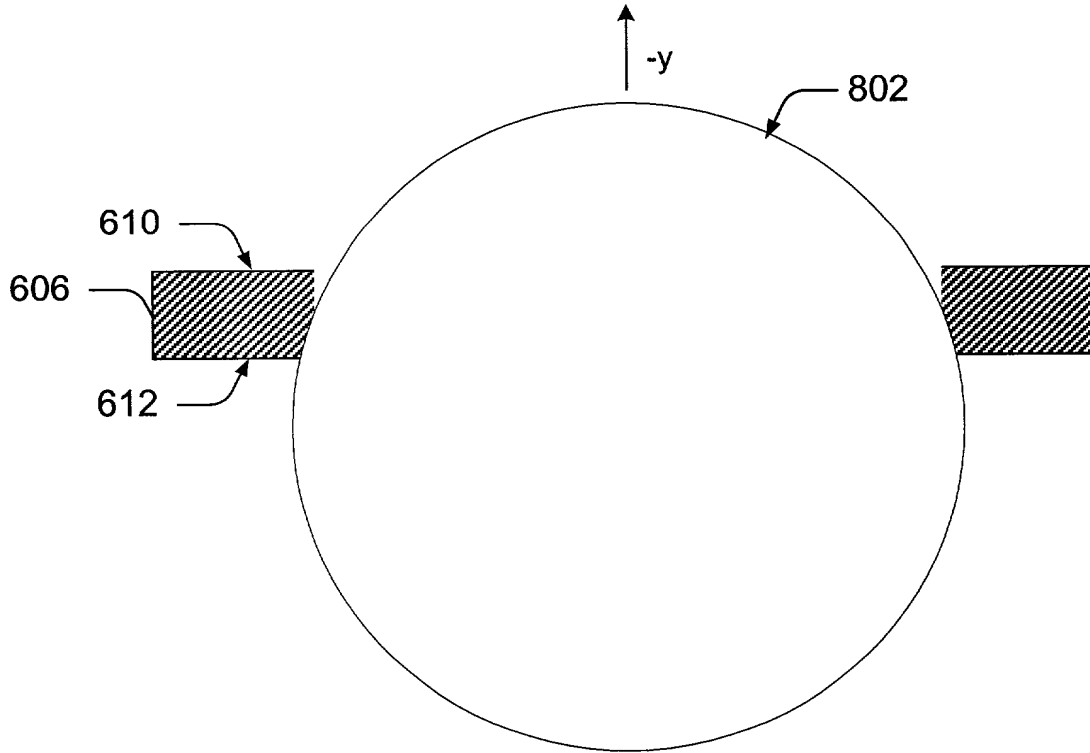

Fig. 10c



Fig. 10d

20250720 14:58:00

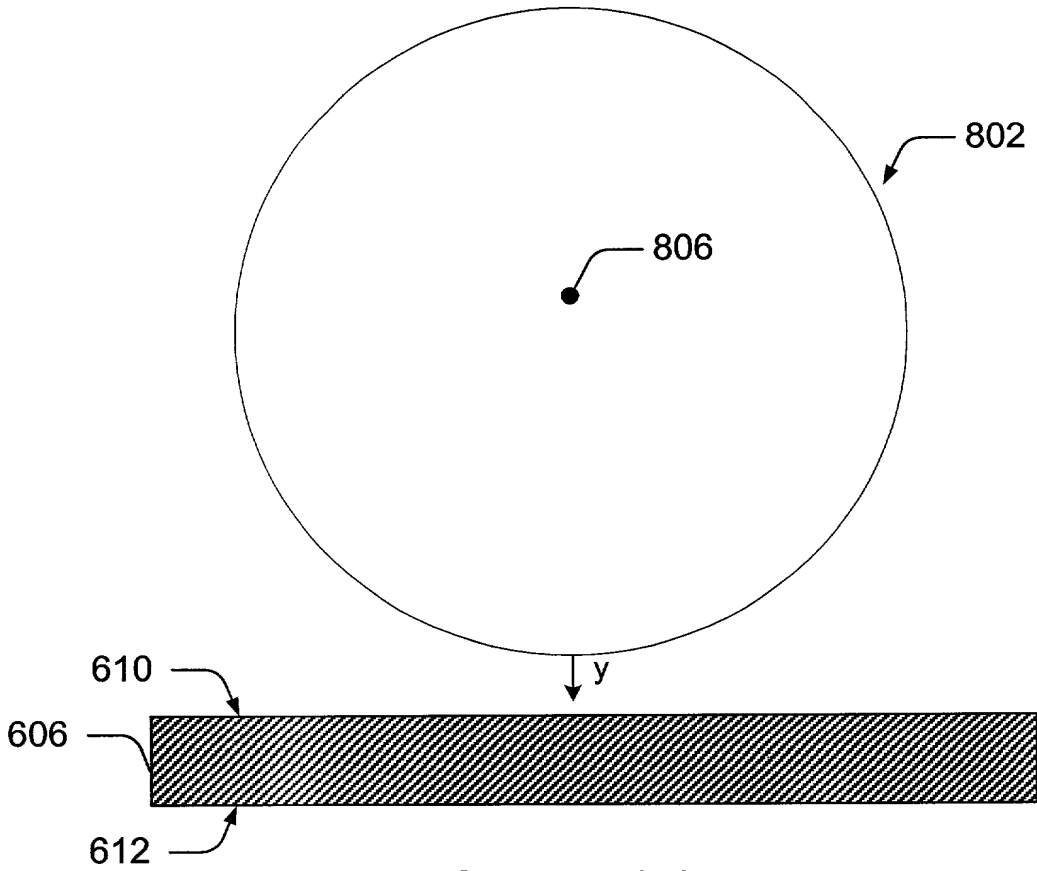

Fig. 11a

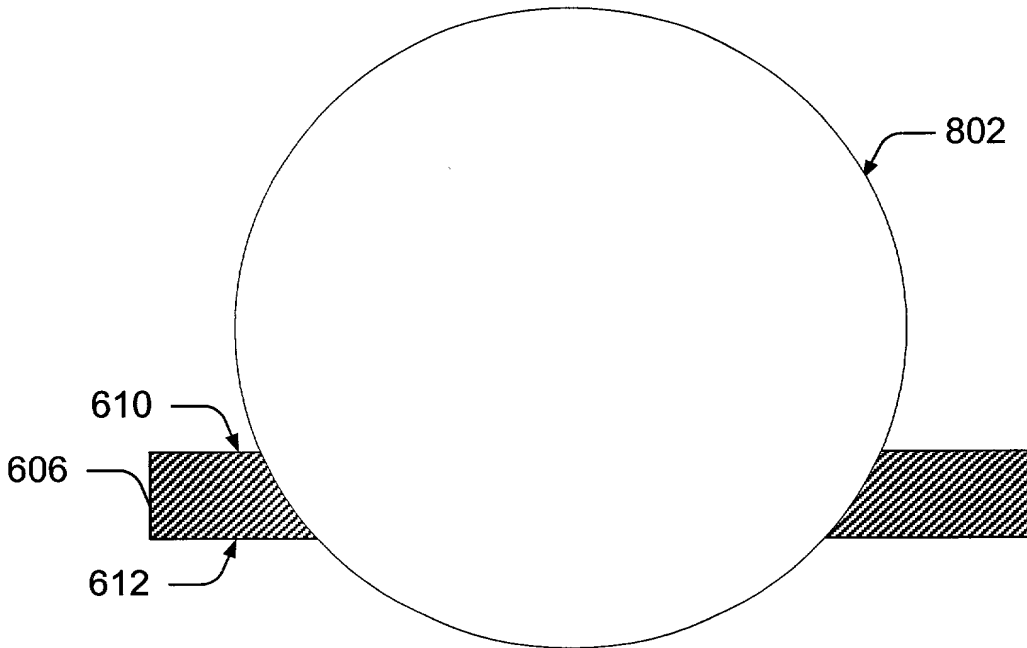

Fig. 11b

20250728 14:59:00

